

## 9.9-12.5Gb/s Optical Modulator Driver

OC-192 Metro and Long Haul Applications  
Surface Mount Package

## TGA4953-SL

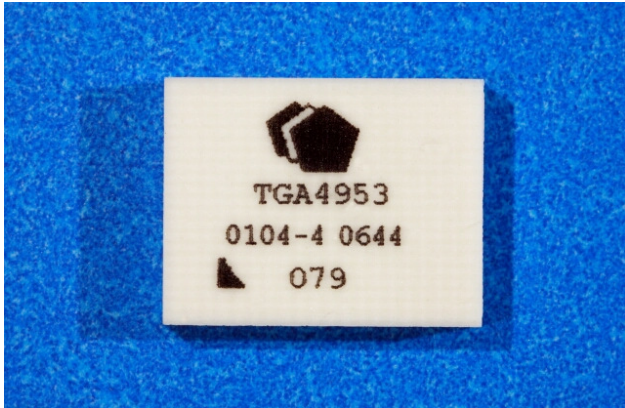

### Description

The TriQuint TGA4953-SL is part of a series of surface mount modulator drivers suitable for a variety of driver applications and is compatible with Metro MSA standards.

The TGA4953-SL consists of two high performance wideband amplifiers combined with off chip circuitry assembled in a surface mount package. A single TGA4953-SL placed between the MUX and Optical Modulator provides OEMs with a board level modulator driver surface mount solution.

The TGA4953-SL provides Metro and Long Haul designers with system critical features such as: low power dissipation (1.1W at  $V_o = 6V$ ), very low rail ripple, high voltage drive capability at 5V bias (6 V amplitude adjustable to 3 V), low output jitter (1 ps rms typical), and low input drive sensitivity (250mV at  $V_o = 6V$ ).

The TGA4953-SL requires external DC blocks, a low frequency choke, and control circuitry.

The TGA4953-SL is available on an evaluation board.

RoHS compliant.

### Key Features and Performance

- Metro MSA Compatible
- Wide Drive Range (3V to 10V)
- Single-ended Input / Output
- Low Power Dissipation  
(1.1W at  $V_o = 6V$ )
- Very Low Rail Ripple
- 25ps Edge Rates (20/80)
- Small Form Factor
  - 11.4 x 8.9 x 2 mm
  - 0.450 x 0.350 x 0.080 inches

### Primary Applications

- Mach-Zehnder Modulator Driver for Metro and Long Haul
- IRZ & Duobinary Applications

### Measured Performance

TGA4953-SL Evaluation Board (Metro MSA Conditions)  
10.7 Gb/s,  $V_{dd} = 5V$ ,  $I_{dd} = 210mA$ , ( $P_{dc} = 1.1W$ )  
 $V_{OUT} = 6V_{PP}$ ,  $CPC = 50\%$ ,  $V_{IN} = 500mV_{PP}$   
Scale: 2 V/div, 15 ps/div

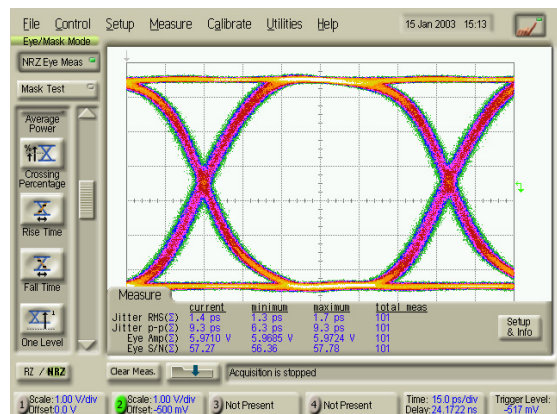

**TABLE I  
MAXIMUM RATINGS**

Symbol	Parameter	Value	Notes
$V_{D1}$ $V_{D2T}$	Drain Voltage	8 V	<u>1/</u> <u>2/</u>
$V_{G1}$ $V_{G2}$	Gate Voltage Range	-3V to 0V	<u>1/</u>
$V_{CTRL1}$ $V_{CTRL2}$	Control Voltage Range	-3V to $V_D$	<u>1/</u>
$I_{D1}$ $I_{D2T}$	Drain Supply Current (Quiescent)	200 mA 350 mA	<u>1/</u> <u>2/</u>
$ I_{G1} $ $ I_{G2} $	Gate Supply Current	15 mA	<u>1/</u>
$ I_{CTRL1} $ $ I_{CTRL2} $	Control Supply Current	15 mA	<u>1/</u> <u>5/</u>
$P_{IN}$	Input Continuous Wave Power	23 dBm	<u>1/</u> <u>2/</u>
$V_{IN}$	12.5Gb/s PRBS Input Voltage	4 $V_{PP}$	<u>1/</u> <u>2/</u>
$P_D$	Power Dissipation	4 W	<u>1/</u> <u>2/</u> <u>3/</u>
$T_{CH}$	Operating Channel Temperature	150 °C	<u>4/</u>
$T_M$	Mounting Temperature (10 Seconds)	230 °C	
$T_{STG}$	Storage Temperature	-65 to 150 °C	

- 1/ These ratings represent the maximum operable values for this device
- 2/ Combinations of supply voltage, supply current, input power, and output power shall not exceed  $P_D$  at a package base temperature of 80°C
- 3/ When operated at this bias condition with a baseplate temperature of 80°C, the MTTF is reduced
- 4/ Junction operating temperature will directly affect the device median time to failure (MTTF). For maximum life, it is recommended that junction temperatures be maintained at the lowest possible levels.
- 5/ Assure  $V_{CTRL1}$  never exceeds  $V_{D1}$ , and  $V_{CTRL2}$  never exceeds  $V_{D2T}$  during bias up and down sequences.

**TABLE II**  
**THERMAL INFORMATION**

Parameter	Test Conditions	T <sub>CH</sub> (°C)	R <sub>θJC</sub> (°C/W)	MTTF (hrs)
R <sub>θJC</sub> Thermal Resistance (Channel to Backside of Package)	V <sub>D2T</sub> = 4.7V I <sub>D2T</sub> = 150mA P <sub>DISS</sub> = 0.71W T <sub>BASE</sub> = 80°C	98	26	>1E6

Note: Thermal transfer is conducted through the bottom of the TGA4953-SL package into the motherboard. The motherboard must be designed to assure adequate thermal transfer to the base plate.

**TABLE III**  
**RF CHARACTERIZATION TABLE**  
(T<sub>A</sub> = 25°C, Nominal)

Parameter	Test Conditions	Min	Typ	Max	Units	Notes
Small Signal Bandwidth			8		GHz	
Saturated Power Bandwidth			12		GHz	
Small Signal Gain	0.1, 2, 4 GHz 6 GHz 10 GHz 14 GHz 16 GHz	30 28 26 19 14			dB	<u>1/</u> <u>2/</u>
Input Return Loss	0.1, 2, 4, 6, 10, 14, 16 GHz	10	15		dB	<u>1/</u> <u>2/</u>
Output Return Loss	0.1, 2, 4, 6, 10, 14, 16 GHz	10	15		dB	<u>1/</u> <u>2/</u>
Noise Figure	3 GHz		2.5		dB	
Small Signal AGC Range	Midband		30		dB	
Saturated Output Power	2, 4, 6, 8 & 10 GHz	25			dBm	<u>6/</u> <u>7/</u>

**TABLE III**  
**RF CHARACTERIZATION TABLE**  
(T<sub>A</sub> = 25°C, Nominal)

Parameter	Test Conditions	Min	Typ	Max	Units	Notes
Eye Amplitude	V <sub>D2T</sub> = 8.0V V <sub>D2T</sub> = 6.5V V <sub>D2T</sub> = 5.5V V <sub>D2T</sub> = 4.5V V <sub>D2T</sub> = 4.0V	10 8.0 7.0 6.0 5.5			V <sub>PP</sub>	<u>3/</u> <u>4/</u>
Additive Jitter (RMS)	V <sub>IN</sub> = 500mV <sub>PP</sub> V <sub>IN</sub> = 800mV <sub>PP</sub>		0.9 1.0	2.0 2.0	Ps	<u>5/</u>
Q-Factor	V <sub>IN</sub> = 500mV <sub>PP</sub> V <sub>IN</sub> = 800mV <sub>PP</sub>	28.5 28.5	35 35		V/V	
Delta Eye Amplitude	500–800 mV in p-p	-0.10		0.10	V <sub>PP</sub>	
Delta Crossing Percentage	500–800 mV in p-p	-6		6	%	

**Table III Notes:**

- 1/ Verified at package level RF test
- 2/ Typical Package RF Test Bias Conditions: V<sub>DD</sub> = 5V, adjust V<sub>G1</sub> to achieve I<sub>DD</sub> = 65mA then adjust V<sub>G2</sub> to achieve I<sub>D2T</sub> = 115 – 155 mA (I<sub>DD</sub> = 180 - 220mA), V<sub>CTRL1</sub> = -0.2V & V<sub>CTRL2</sub> = +0.2 V
- 3/ Verified by design, SMT assembled onto a demonstration board detailed on sheet 6.
- 4/ V<sub>IN</sub> = 250mV, Data Rate = 10.7Gb/s, V<sub>D1</sub> = V<sub>D2T</sub> or greater, V<sub>CTRL2</sub> and V<sub>G2</sub> are adjusted for maximum output. Typical final I<sub>DD</sub> under drive ~ 220 mA.
- 5/ Computed using RSS Method where  $J_{RMS\_DUT} = \sqrt{(J_{RMS\_TOTAL}^2 - J_{RMS\_SOURCE}^2)}$
- 6/ Verified at die level on-wafer probe
- 7/ Power Bias Die Probe: V<sub>TEE</sub> = 8V, adjust V<sub>G</sub> to achieve I<sub>DD</sub> = 175mA ±5%, V<sub>CTRL</sub> = +1.5V

Note: At the die level, drain bias is applied through the RF output port using a bias tee, voltage is at the DC input to the bias tee

### Demonstration Board

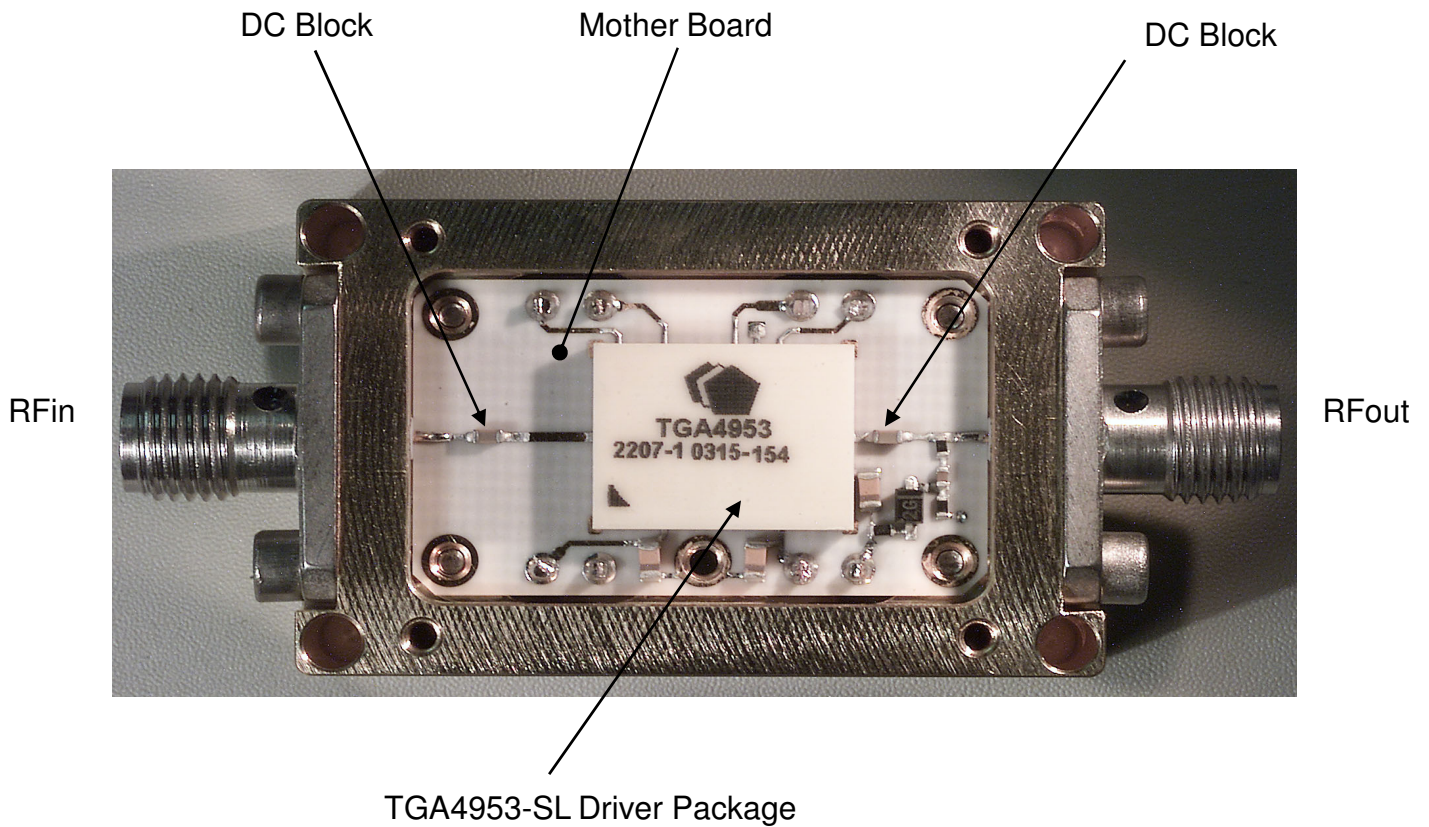

*Note: Devices designated as EPU are typically early in their characterization process prior to finalizing all electrical and process specifications. Specifications are subject to change without notice.*

## Demonstration Board Application Circuit

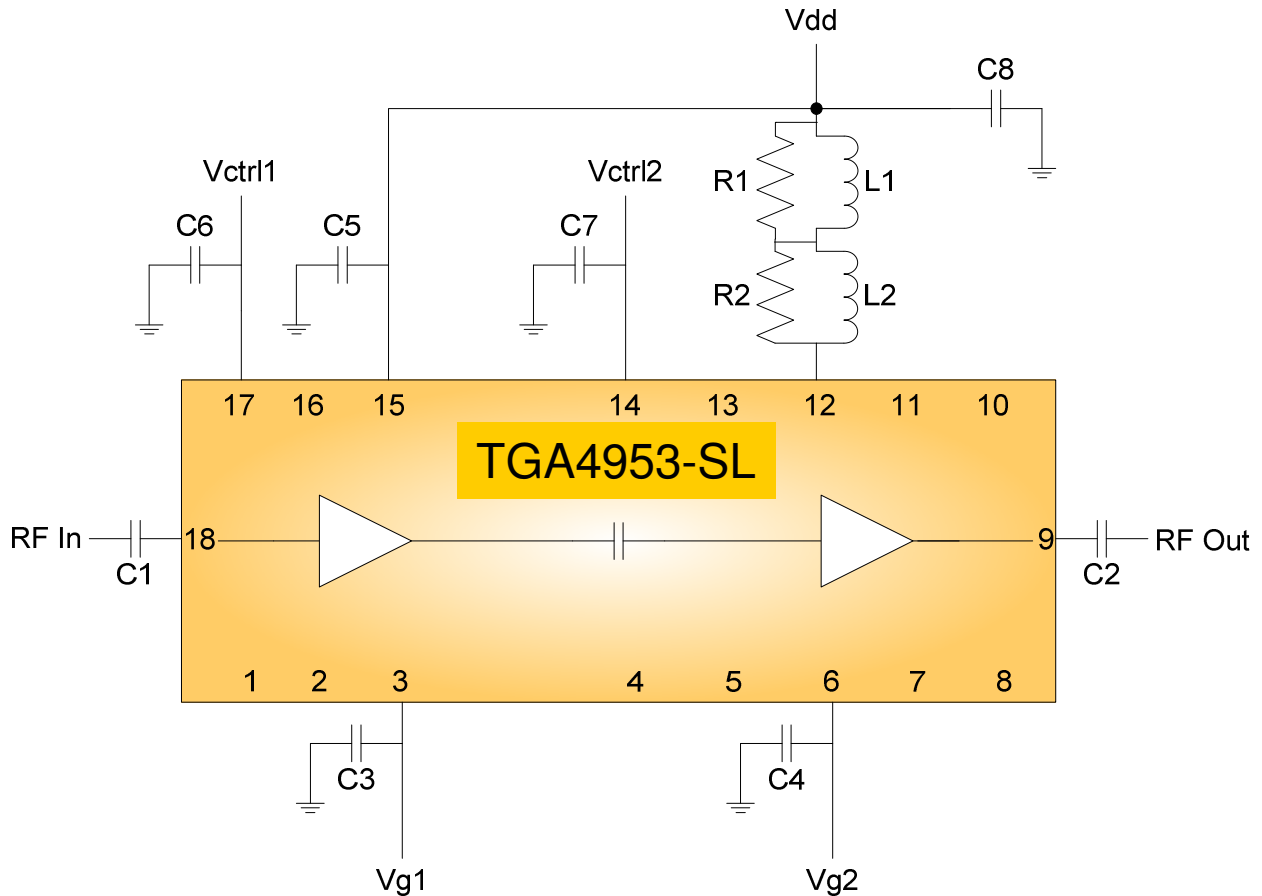

### Notes:

1. C3 and C4 extend low frequency performance thru 30 KHz. For applications requiring low frequency performance thru 100 KHz, C3 and C4 may be omitted
2. C5 is a power supply decoupling capacitor and may be omitted
3. C6 and C7 are power supply decoupling capacitors and may be omitted when driven directly with an op-amp. Impedance looking into VCTRL1 and VCTRL2 is 10k $\Omega$  real

## Demonstration Board Application Circuit (Continued)

### Recommended Components:

DESIGNATOR	DESCRIPTION	MANUFACTURER	PART NUMBER
C1, C2	DC Block, Broadband	Presidio	BB0502X7R104M16VNT9820
C3, C4, C5	10uF Capacitor MLC Ceramic	AVX	0805YC106KA
C6, C7	0.01 uFCapacitor MLC Ceramic	AVX	0603YC103KA
C8	10 uF Capacitor Tantalum	AVX	TAJT106K016
L1	220 uH Inductor	Panasonic or Belfuse	ELLCTV221M S581-4000-14
L2	330 nH Inductor	Panasonic	ELJ-FAR33MF2
R1, R2	274 $\Omega$ Resistor	Panasonic	ERJ2RKD274



**TGA4953-SL Typical Performance Data  
is measured in a Test Fixture**

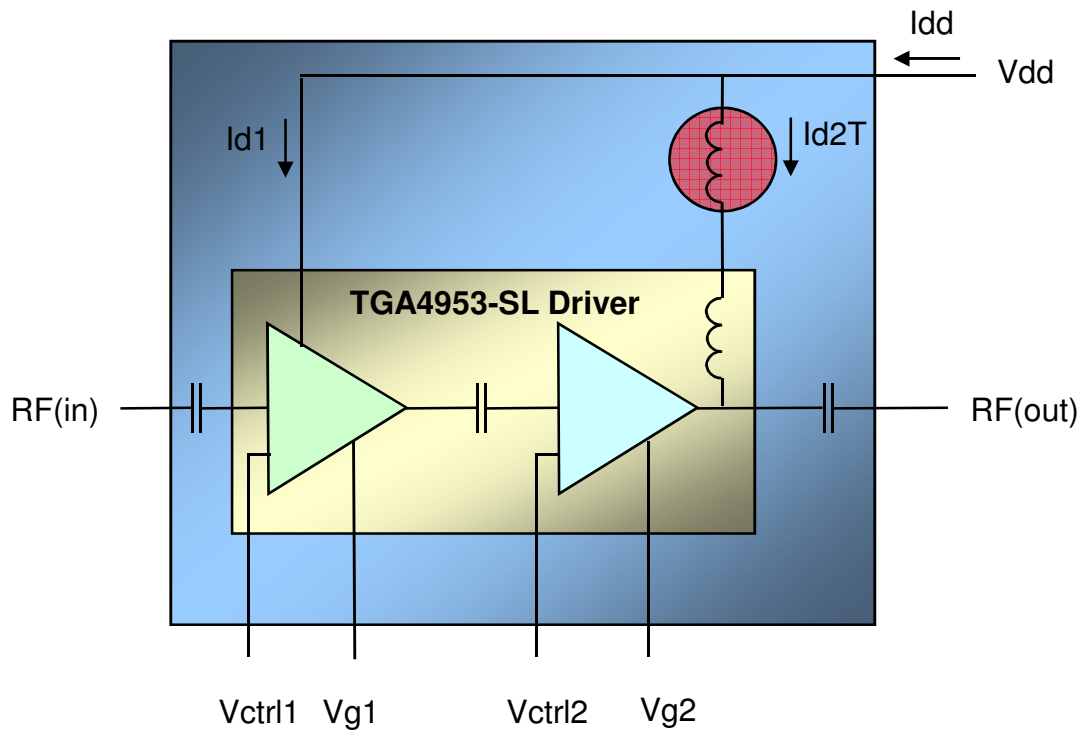

**Test Fixture Block Diagram**

**Typical Measured Performance on Demonstration Board**  
**10.7Gb/s 2<sup>A</sup>31-1, V<sub>dd</sub>=5V**  
**CPC=50%**

**Vo=6V**

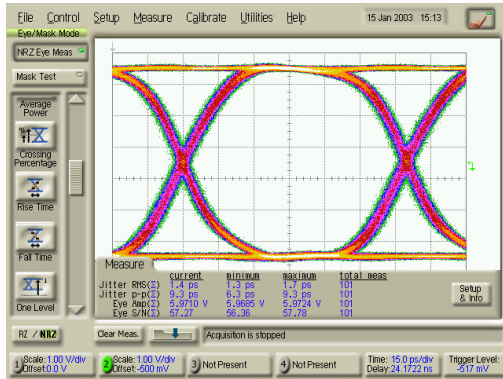

**Vo=5V**

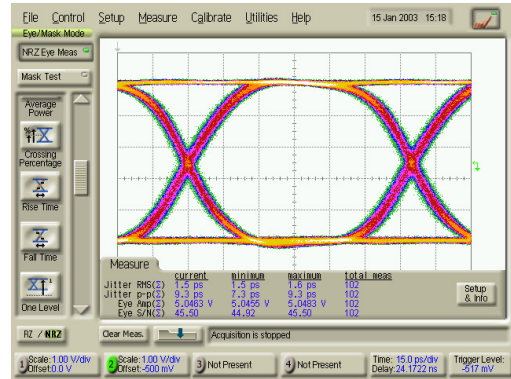

**Vo=4V**

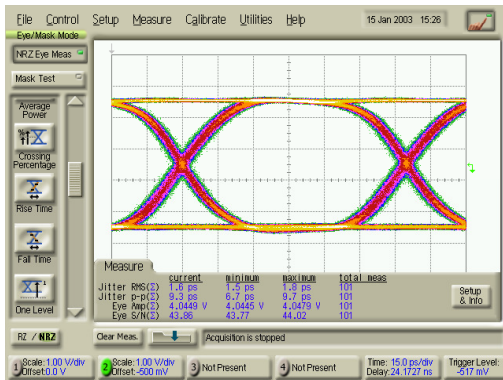

**Vo=3V**

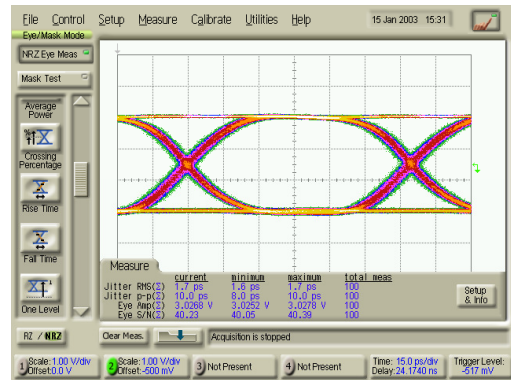

**Input Signal Vin=500mV**

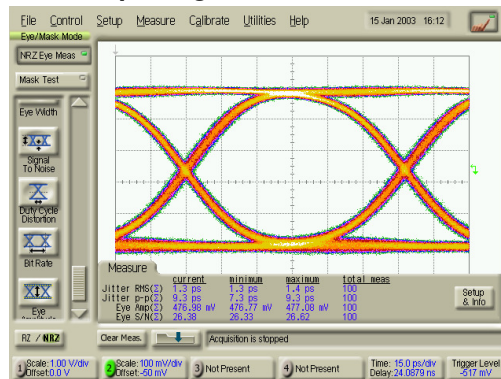

**Typical Measured Performance on Demonstration Board**  
**IRZ 2^31-1, Vdd=8V**  
**Vin=800mVpp**

**9.953Gbps**

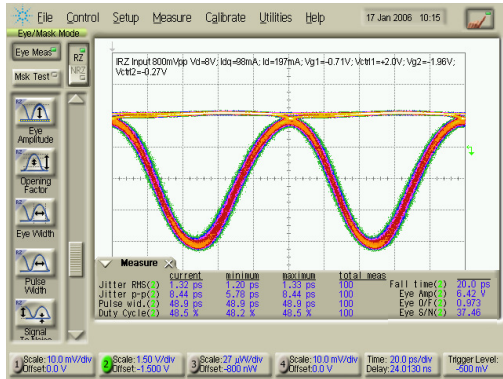

**10.7Gbps**

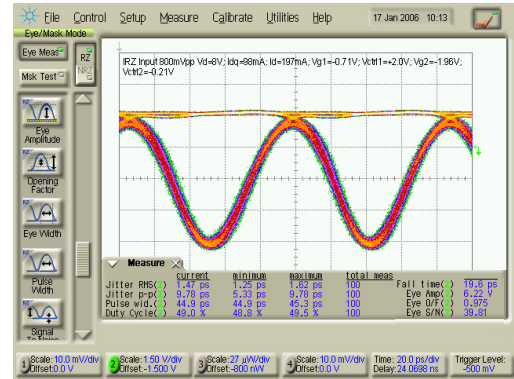

**11.3Gbps**

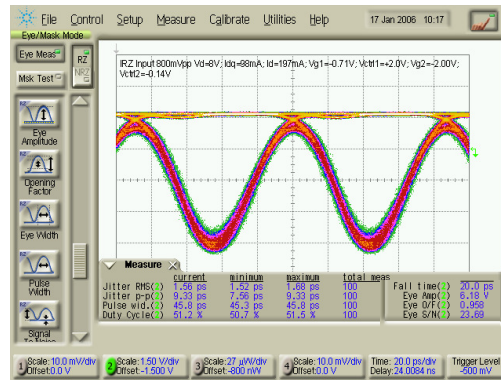

**Input Signal 10.7Gbps**

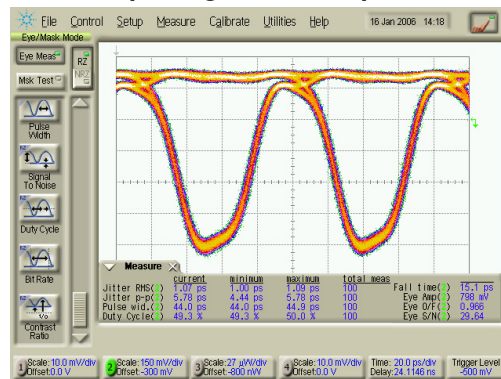

**Typical Bias Conditions**  
**Vdd=5V**

Vo(V)	Vg1(V)	Vg2(V)	Idd	Vctrl2
6	-0.66	-0.57	221	+0.22
5	-0.66	-0.59	198	+0.04
4	-0.66	-0.67	172	-0.14
3	-0.66	-0.74	147	-0.34

Notes:

1. Vdd=5V, Id1=65mA, and Vctrl1=-0.2V
2. Vin=500mVpp
3. 50%CPC
4. Actual bias points may be different.

**General Comments for Production Operation of TGA4953-SL:**

1. Due to natural variations in gate voltages observed with GaAs FET amplifiers used internally to the TGA4953-SL, optimal eye performance is obtained when the gate voltages (Vg1 and Vg2) are set to control desired drain currents (Id1 and Id2T)
2. Vc2 feedback circuit recommended for output amplitude correction.

**Demonstration Board - Bias ON/OFF Procedure**  
**Vdd=5V, Vo=6Vamp, CPC=50%**  
(Hot Pluggable)

**Bias ON**

1. Disable the output of the PPG
2. Set Vdd=0V Vctrl1=0V Vctrl2=0 Vg1=0V and Vg2=0V
3. Set Vg1=-1.5V Vg2=-1.5V **Vctrl1=-0.2V**
4. Increase Vdd to 5V observing Idd.
  - Assure Idd=0mA
5. Set Vctrl2=+0.2V
  - Idd should still be 0mA
6. Make Vg1 more positive until **Idd=65mA**.
  - This is Id1 (current into the first stage)
  - Typical value for **Vg1 is -0.65V**
7. Make Vg2 more positive until Idd=180 – 220 mA.
  - This sets Id2T to 115 -155 mA.
  - Typical value for Vg2 is -0.55V
8. Enable the output of the PPG.
  - Set Vin=500mV
9. **Output Swing Adjust:** Adjust **Vctrl2** slightly positive to increase output swing or adjust Vctrl slightly negative to decrease the output swing.
  - Typical value for **Vctrl2 is +0.22V** for Vo=6V.
10. **Crossover Adjust:** Adjust **Vg2** slightly positive to push the crossover down or adjust Vg2 slightly negative to push the crossover up.
  - Typical value for **Vg2 is -0.57V** to center crossover with Vo=6V.

**Bias OFF**

1. Disable the output of the PPG
2. Set Vctrl2=0V
3. Set Vdd=0V
4. Set Vctrl1=0V
5. Set Vg2=0V
6. Set Vg1=0V

**Production - Initial Alignment - Bias Procedure**  
**Vdd=5V, Vo=6Vamp, CPC=50%**  
(Hot Pluggable)

**Bias Network Initial Conditions -**

Vg1=-1.5V  
Vg2=-1.5V  
Vctrl1=-0.2V  
Vctrl2=+.1V  
Vdd=5V

**Bias ON**

1. Disable the output of MUX
2. Apply Vg1, Vg2, Vctrl1, Vctrl2, and Vdd in any sequence.  
Note: If Vdd is applied first Idd could reach near 400mA.
3. Make Vg1 more positive until **Idd=65mA**.  
- This is Id1 (current into the first stage)  
- Typical value for **Vg1 is -0.65V**
4. Make Vg2 more positive until Idd=180 - 220mA.  
- This sets Id2T to 115 - 155 mA.  
- Typical value for Vg2 is -0.55V
5. Enable the output of the MUX.  
- Set Vin=500mV
6. Output Swing Adjust: Adjust Vctrl2 slightly positive to increase output swing or adjust Vctrl2 slightly negative to decrease the output swing.  
- Typical value for **Vctrl2 is +0.22V** for Vo=6V.
7. Crossover Adjust: Adjust Vg2 slightly positive to push the crossover down or adjust Vg2 slightly negative to push the crossover up.  
- Typical value for **Vg2 is -0.57V** to center crossover with Vo=6V.

**Bias OFF**

Remove Vg1, Vg2, Vctrl1, Vctrl2, and Vdd in any sequence.

**Production - Post Alignment - Bias Procedure**  
**Vdd=5V, Vo=6Vamp, CPC=50%**  
(Hot Pluggable)

**Bias Network Initial Conditions -**

Vg1= As found during initial alignment  
Vg2=-As found during initial alignment  
Vctrl1=-0.2V  
Vctrl2=As found during initial alignment  
Vdd=5V

**Bias ON**

1. Mux output can be either Enabled or Disabled
2. Apply Vg1, Vg2, Vctrl1, Vctrl2, and Vdd in any sequence.  
Note: If Vdd is applied first Idd could reach near 400mA.
3. Enable the output of the MUX
4. Output Swing Adjust: Adjust Vctrl2 slightly positive to increase output swing or adjust Vctrl slightly negative to decrease the output swing.
5. Crossover Adjust: Adjust Vg2 slightly positive to push the crossover down or adjust Vg2 slightly negative to push the crossover up.

**Bias OFF**

Remove Vg1, Vg2, Vctrl1, Vctrl2, and Vdd in any sequence.

**General Comments for Production Operation of TGA4953-SL:**

1. Due to natural variations in gate voltages observed with GaAs FET amplifiers used internally to the TGA4953-SL, optimal eye performance is obtained when the gate voltages (Vg1 and Vg2) are set to control desired drain currents (Id1 and Id2T)
2. Vc2 feedback circuit recommended for output amplitude correction.

## **Production - Initial Alignment – IRZ Bias Procedure** **Vdd=8V, Vo=6Vamp** (Hot Pluggable)

### **Bias Network Initial Conditions -**

Vg1=-1.5V  
Vg2=-2.0V  
Vctrl1=+1.0V  
Vctrl2=+2.0V  
Vdd=8V

### **Bias ON**

1. Disable the output of MUX
2. Apply Vg1, Vg2, Vctrl1, Vctrl2, and Vdd in any sequence.  
Note: If Vdd is applied first Idd could reach near 400mA.
3. Make Vg1 more positive until **Idd=80mA**.
  - This is Id1 (current into the first stage)
  - Typical value for **Vg1 is -0.55V**
4. Enable the output of the MUX.
  - Set Vin=800mV
5. Crossover Adjust: Adjust Vg2 slightly negative to push the crossover towards zero level.
6. Output Swing Adjust: Adjust Vctrl2 slightly positive to increase output swing or adjust Vctrl2 slightly negative to decrease the output swing.
7. Duty Cycle Fine Tune: Adjust Vctrl1 slightly negative to reduce duty cycle percentage.
8. Readjust Vctrl2 for proper output amplitude.

### **Bias OFF**

Remove Vg1, Vg2, Vctrl1, Vctrl2, and Vdd in any sequence.



### Mechanical Drawing

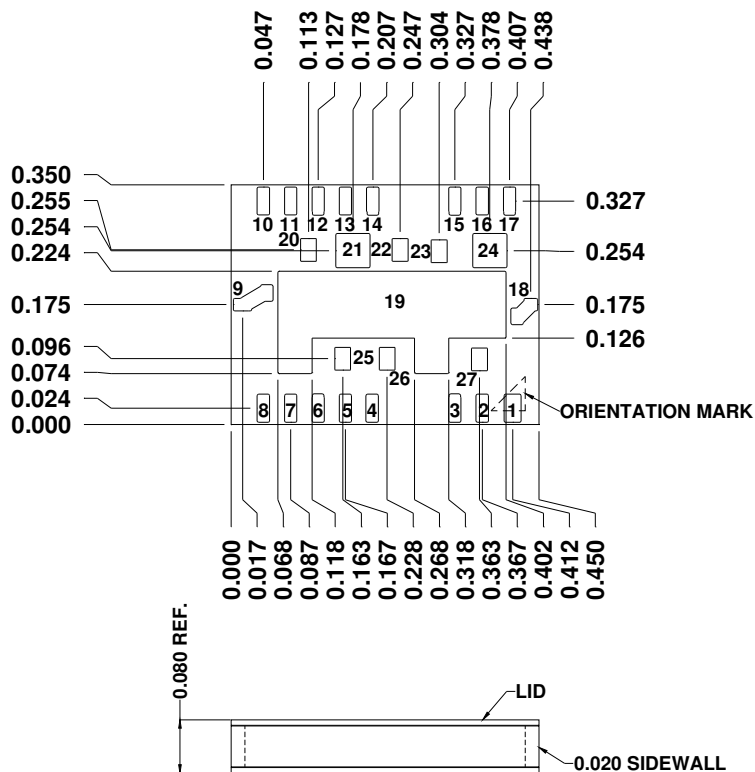

Pin #1	N/C	0.025 x 0.041	Pin #15	Vd1	0.018 x 0.041
Pin #2	N/C	0.018 x 0.041	Pin #16	N/C	0.018 x 0.041
Pin #3	Vg1	0.018 x 0.041	Pin #17	Vctrl1	0.018 x 0.041
Pin #4	N/C	0.018 x 0.041	Pin #18	RF In	0.020 x 0.018
Pin #5	N/C	0.018 x 0.041	Pin #19	GND	
Pin #6	Vg2	0.018 x 0.041	Pin #20	GND	0.023 x 0.033
Pin #7	N/C	0.018 x 0.041	Pin #21	GND	0.049 x 0.049
Pin #8	N/C	0.018 x 0.041	Pin #22	GND	0.023 x 0.033
Pin #9	RF Out	0.027 x 0.018	Pin #23	GND	0.023 x 0.033
Pin #10	N/C	0.018 x 0.041	Pin #24	GND	0.049 x 0.049
Pin #11	N/C	0.018 x 0.041	Pin #25	GND	0.023 x 0.033
Pin #12	Vd2T	0.018 x 0.041	Pin #26	GND	0.023 x 0.033
Pin #13	N/C	0.018 x 0.041	Pin #27	GND	0.023 x 0.033
Pin #14	Vctrl2	0.018 x 0.041			

**Notes:**

- Dimensions: Inches. Tolerance: Length and Width: +/- .003 inches. Height +/- .006 inches. Adjacent pad to pad spacing: +/- .0002 inches. Pad Size: +/- .001 inches.
- Surface Mount Interface:  
 Material: RO4003 (thickness=.008 inches), 1/2oz copper (thickness=.0007 inches)  
 Plating Finish: 100-350 microinches nickel underplate, with 5-10 microinches flash gold overplate.
- Note for Pin 13: Pin 13 can be soldered to the PCB but MUST be left electrically open.

## Recommended Surface Mount Package Assembly

Proper ESD precautions must be followed while handling packages.

Clean the board with acetone. Rinse with alcohol. Allow the circuit to fully dry.

TriQuint recommends using a conductive solder paste for attachment. Follow solder paste and reflow oven vendors' recommendations when developing a solder reflow profile. Typical solder reflow profiles are listed in the table below.

Hand soldering is not recommended. Solder paste can be applied using a stencil printer or dot placement. The volume of solder paste depends on PCB and component layout and should be well controlled to ensure consistent mechanical and electrical performance. *This package has little tendency to self-align during reflow.*

TriQuint recommends using no-clean solder for the TGA4953-SL. If cleaning is required, then de-ionized water or isopropyl alcohol solutions are acceptable.

### Typical Solder Reflow Profiles

Reflow Profile	SnPb	Pb Free
Ramp-up Rate	3 °C/sec	3 °C/sec
Activation Time and Temperature	60 – 120 sec @ 140 – 160 °C	60 – 180 sec @ 150 – 200 °C
Time above Melting Point	60 – 150 sec	60 – 150 sec
Max Peak Temperature	240 °C	260 °C
Time within 5 °C of Peak Temperature	10 – 20 sec	10 – 20 sec
Ramp-down Rate	4 – 6 °C/sec	4 – 6 °C/sec

### Environmental Ratings

Moisture Sensitivity Rating	ESD Rating
MSL5A	1A

### Ordering Information

Part	Package Style
TGA4953-SL	Land Grid Array Surface Mount (RoHS Compliant)

***GaAs MMIC devices are susceptible to damage from Electrostatic Discharge. Proper precautions should be observed during handling, assembly and test.***